

# NISSAN NAVARA, PATHFINDER & X-TRAIL ACCESSORIES

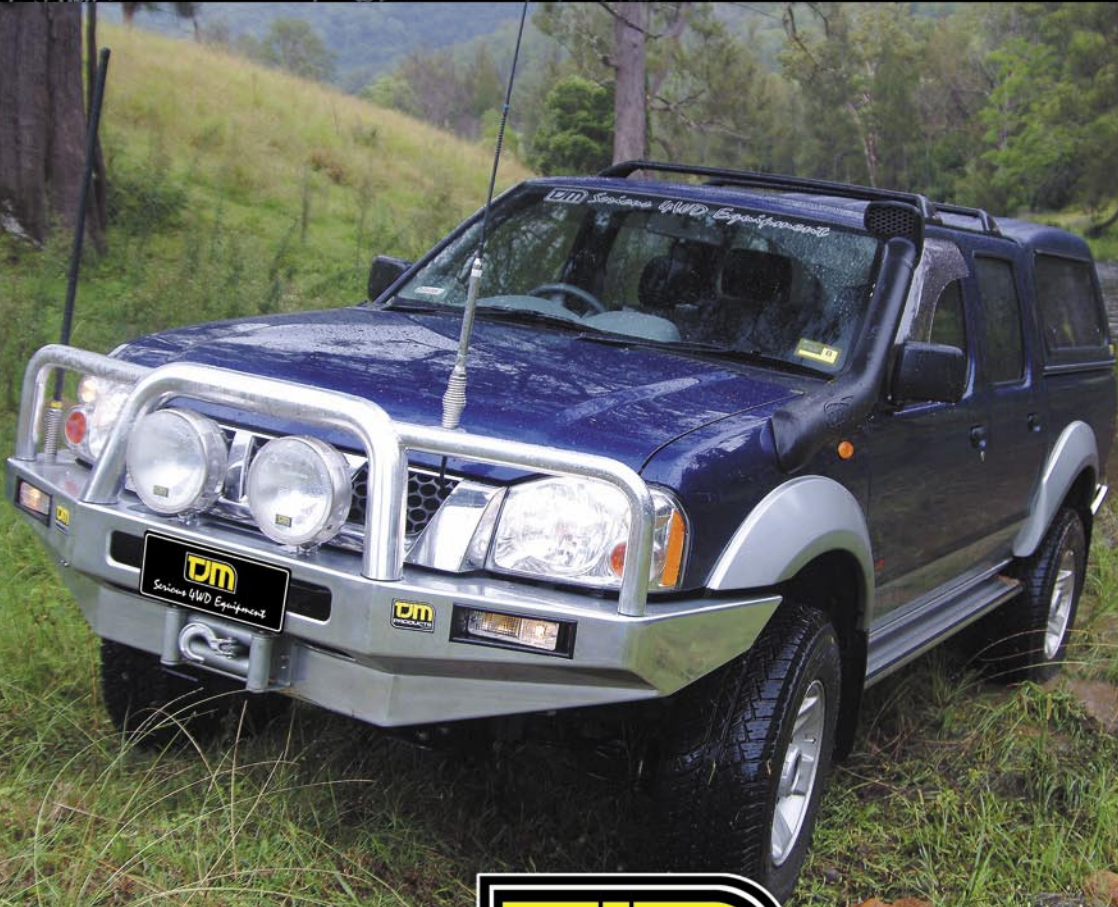

*Serious 4WD Equipment*

[www.tjmproducts.com.au](http://www.tjmproducts.com.au)



...a member of the group



## T15 - Frontal Protection Bar

TJM T15 Bars offer style and function, with innovative safety features that are renowned from TJM. A sleek design with tapered wings ensures maximum approach angle is maintained. TJM T15 Bars are manufactured in both steel and alloy....

- **STEEL BAR** - 3mm channel design
- 2.5mm & 2.6mm tubing wall thickness
- High tensile chassis mounting bolts
- Provision for Electric and Ox Hydraulic winches
- ADR approved indicator/park lights
- Driving light provision
- Press formed communication aerial tab
- Durable 'Black' powder coat finish

- **ALLOY BAR** - 4mm channel design
- 3.2mm & 4.7mm tubing wall thickness
- High tensile chassis mounting bolts
- Provision for Electric and Ox Hydraulic winches
- ADR approved indicator/park lights
- Driving light provision
- Press formed communication aerial tab
- Highly polished finish



## T16 - Frontal Protection Bar

TJM T16 Nudge Bars are designed to maintain the character of your vehicle. Light weight and fitting over the original bumper, they will provide protection to the original bumper and grille.

- 76mm highly polished tube frame
- 4.7mm wall thickness tubing
- 5mm press formed centre brace
- Air Bag Compatible mounting system
- Driving light provision
- Optional stainless steel aerial bracket

NOTE: ON ALL BARS, DRIVING LIGHTS, WINCH, WINCH FRAME AND ROLLERS ARE OPTIONAL.



## Steel Side Bars with Alloy Step

TJM 3/4 Side Bars are manufactured from 50mm steel tube and are designed to offer protection to vehicle body panels, wheel arches, flares and sills. The 3/4 Side Bars are mounted to the vehicle sub-frame with black polyester powder-coated steel mounts and are joined to the Frontal Protection Bar with TJM Side Bar Clamps. An extruded aluminium step tread with non-slip edge and moulded end caps provide easy access to the vehicle.

- 50mm Steel Tubing
- Engineered Steel Chassis Mounts
- Durable 'Black' powder coat finish
- Extruded Aluminium Step Tread
- Rubber Anti-Slip Edge



**TJM Canopies**  
Available All Models

On the job, or away on a trip, TJM Canopies will take the harshest conditions in their stride. Not only are they tough and durable, they combine practical design and style along with a host of features you've always wanted in a vehicle canopy. All TJM Canopies are 100% Australian made by TJM Products, a world leader in the design and manufacture of Serious 4wd Equipment. The quality of every canopy is guaranteed by TJM's quality assurance to International Standard ISO9001.

OPTIONAL SIDE ACCESS WINDOW SHOWN



OPTIONAL LADDER RACKS SHOWN

**Standard Features:**

- Hand-laid fibreglass shell
- Lockable tinted rear tailgate
- Australian Made
- Parts/spares are readily available
- Quality Assured to ISO9001

**Options include:**

- Side Access Doors/Windows
- Front Fold Down Window
- Security Mesh
- Interior Roof Lining
- Air Vents
- Rear Brake Light
- Medium Duty Carry Racks
- Paint Colour Coding

*TJM sales can assist in advising the appropriate canopy and options.*



**TJM Ute Liner**

The 'TJM' Ute Liner is custom moulded to suit your Navara and is easily installed. The liner is moulded to the tray ensuring that it is fully supported in all areas, Moulded slots on the side of the liner allows fitting of the unique optional 'Load Lok System' which helps keep your cargo in place. Made from high impact polyethylene plastic which is resistant to UV light, petrol, diesel, battery acid and most other chemicals.

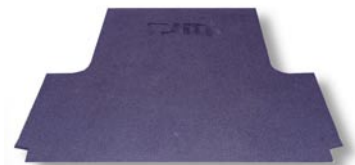

**TJM - Ute Mats**

TJM Ute Mats are custom moulded to suit your vehicle and are easily installed. The mats are manufactured from 8mm thick, heavy duty recycled rubber.



10/01+ DIESEL MODEL SHOWN - LHS

**TJM Airtec Snorkel**

Four reasons why it's important 4WD engines should enjoy the TJM Airtec advantage.

1. Fitting a TJM Airtec Snorkel means the air supply is drawn from roof level providing cooler and cleaner air to the engine.
2. Because the air supply is drawn from roof level, dust is not as thick and plentiful as in the engine bay or inner guard. This will help extend the life of the air cleaner element, therefore reducing wear of vital components.
3. With the positively sealed TJM Airtec Snorkel, well above water level, you can expect worry-free water crossings.
4. As the vehicle travels, the TJM Airtec Snorkel creates what's known as a ram air effect, that has been often found to increase engine performance.

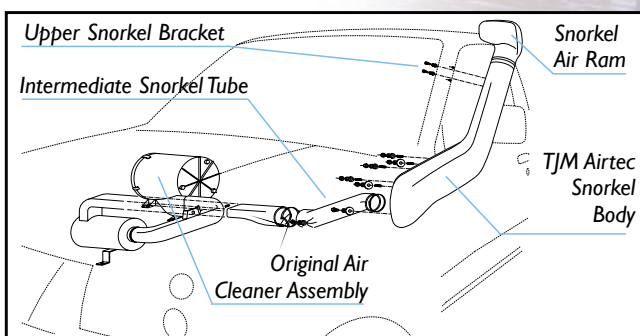

10/01+ DIESEL MODEL SHOWN - ILLUSTRATED ( LHS )

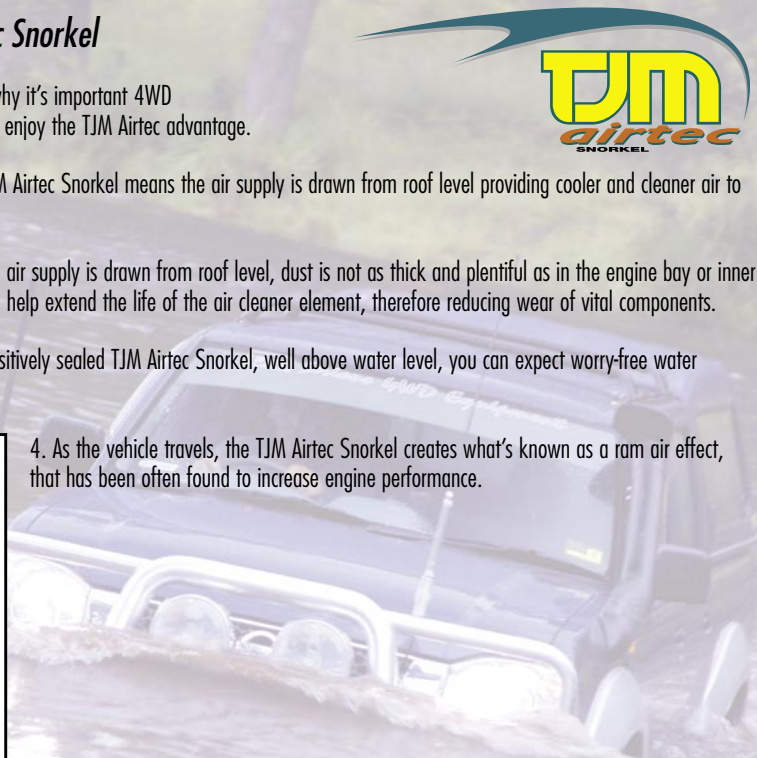



TJM XGS Shock Absorbers

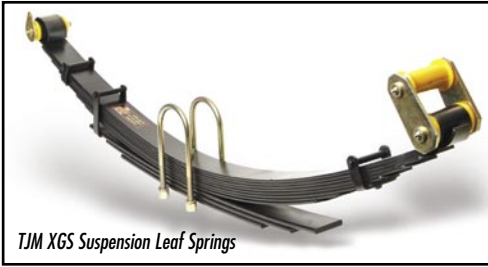

TJM XGS Suspension Leaf Springs



TJM XGS Suspension Torsion Bars



U-Bolts



Greasable Spring Hangers



PolyAir Belows

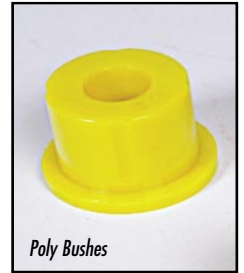

Poly Bushes



3.0ltr Turbo Diesel Shown

### TJM Dual Battery Systems & Trays

TJM have 2 Dual Battery Management Systems available for the Nissan Navara, the TJM IBS and DBS Battery Management Systems.

The TJM Dual Battery Frames are designed and laser cut from 2mm cold rolled steel and critical joints are fully precision MIG welded for maximum strength. Sandblasted and finished in an Anti-Scuff Polyester Powdercoat they are supplied complete with mounting hardware including battery clamps. 3 Year Warranty.

Consult your TJM Distributor for further information. Note: Both systems require battery, frame and auxiliary outlet.

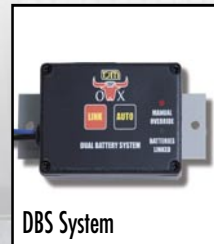

DBS System



IBS System



Ox 10,000lb Hydraulic Winch



Ox 10,000lb Electric Winch

### Winches – Vehicle Recovery

TJM offer the Ox 10,000lb (hydraulic) and Ox 10,000lb (electric), to assist with vehicle recovery. Both winches include wire rope, roller fairlead guide, free spooling clutch, automatic brake, and remote hand control. Hydraulic winch requires individual vehicle hose kit. Consult the TJM Recovery Brochure or your TJM Distributor for further information.

### Ox Vehicle Recovery Equipment

TJM offers a range of Ox Recovery Equipment including...

- Snatch-um-Straps
- Winch Ext Straps
- Bow & 'D' Shackles
- Tree Trunk Protectors
- Snatch Blocks
- Air Jacks
- Recovery Bags
- Ox Compressor
- Wheel Covers
- Tow Hooks
- Drag Chains
- Ox Air Compressor



### TJM XGS - Shock Absorbers

TJM XGS Suspension have a number of kits available for all Navaras to meet specific needs. Towing, load carrying & ground clearance can all be improved while still retaining ride quality. Choose from raised or constant load hi-lift kits with TJM XGS Gas Charged and X-panded Gas Charged Shock Absorbers.



### TJM XGS - Leaf Springs

The original leaf springs of the Navara are considered by some to be harsh riding, and often sag with age or when under constant load. TJM XGS Suspension resolves these problems with heavy duty springs of multi-leaf design. Australian made, using high grade steel, each spring is pre-stressed to eliminate the possibility of sagging. TJM XGS Springs are available in either medium or constant load carrying capacities.

### TJM XGS - Accessories

**TORSION BARS** - Are available to improve the vehicles load carrying ability and stability. Increased spring rate ensures ride height is maintained, especially when the vehicle is fitted with load bearing accessories, ie: Protection Bars and Winches.

**STEERING DAMPER** - For superior steering and shimmy control, fit a TJM XGS 35mm Big Bore Steering Damper.

**POLYAIR SPRINGS & BELLOWS SYSTEM** - Coupled with TJM XGS Springs and Shock Absorbers, the Polyair Spring further assists in solving suspension problems and greatly improves handling, ride height and stability of your vehicle. A pressure increase of between 5 to 25psi (Polyair) and 5 to 100psi (Bellows) will give a load increase of between 10 to 60%.

**POLY BUSH KITS** - Manufactured from resilient high grade polyurethane, these bushes are designed to reduce suspension noise, vibration and harshness.

FOR FURTHER INFORMATION REFER TO THE TJM XGS SUSPENSION BROCHURE OR CONTACT YOUR TJM DISTRIBUTOR

# NISSAN PATHFINDER ACCESSORIES



## T16 - Frontal Protection Bar



TJM T16 Nudge Bars are designed to maintain the character of your vehicle. Light weight and fitting over the original bumper, they will provide protection to the original bumper and grille.

- 76mm highly polished tube frame
- 4.7mm wall thickness tubing
- 5mm press formed centre brace
- Air Bag Compatible mounting system
- Driving light provision
- Optional stainless steel aerial bracket

NOTE: ON ALL BARS DRIVING LIGHTS ARE OPTIONAL.



Coils and Shock Absorbers

## TJM XGS - Shock Absorbers

TJM XGS Suspension offer Bilstein Shock Absorbers for both the front and rear of the Pathfinder.

## TJM XGS - Coil Springs

TJM XGS Coil Springs are available in heavy duty load carrying capacities.

## TJM XGS - Accessories

**TORSION BARS** - Are available to improve the vehicles load carrying ability and stability. Increased spring rate ensures ride height is maintained, especially when the vehicle is fitted with load bearing accessories.  
2/86 10/95 Models Only

**POLYAIR SPRINGS** - The Polyair spring further assists in solving suspension problems and greatly improves handling, ride height and stability of your vehicle. A pressure increase of between 5 to 25psi (Polyair) will give a load increase of between 10 to 60%.



Torsion Bars

FOR FURTHER INFORMATION CONTACT YOUR TJM DISTRIBUTOR

# NISSAN X-TRAIL ACCESSORIES



## T5 - Frontal Protection Bar



TJM T5 Frontal Protection Bars are designed to maintain the character of your vehicle. Light weight and fitting over the original bumper, they will provide protection to the original bumper and grille.

- 63.5mm highly polished centre tube frame
- 45mm highly polished outer loops
- Air Bag Compatible mounting system
- Optional stainless steel aerial bracket
- Driving light provision

ON ALL BARS DRIVING LIGHTS ARE OPTIONAL.

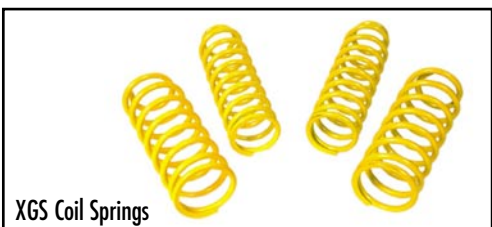

XGS Coil Springs

## TJM XGS SUSPENSION

For the Nissan X-Trail, TJM XGS Suspension offers XGS Coil Springs for the front and rear.

FOR FURTHER INFORMATION CONTACT YOUR TJM DISTRIBUTOR





# Serious 4WD Equipment



## AUSTRALIAN DISTRIBUTION NETWORK

**TJM PRODUCTS PTY LTD - HEAD OFFICE & FACTORY**  
 150 Robinson Road, Geebung, Brisbane, Queensland 4034 Australia.  
 Ph: (07) 3865 9999 / Fax (07) 3865 3677  
**International**  
 Ph: (617) 3865 9999 / Fax: (617) 3216 5299  
**Website** www.tjmproducts.com.au  
**Email** info@tjmproducts.com.au

**QUEENSLAND**  
**BRISBANE - COOPERS PLAINS**  
 959 Beaudesert Road, Coopers Plains, Qld 4108  
 Ph: (07) 3277 8255 / Fax: (07) 3277 8446

**BRISBANE - ENOGGERA**  
 108 Pickering Street, Enoggera, 4051  
 Ph: (07) 3855 4444 / Fax: (07) 3855 4244

**BRISBANE - GEEBUNG**  
 138 Robinson Road, Geebung, 4034  
 Ph: (07) 3633 0377 / Fax: (07) 3265 2147

**BRISBANE - WOOLLOONGABBA**  
 199 Logan Road, Woolloongabba, 4102  
 Ph: (07) 3391 0055 / Fax: (07) 3391 0099

**BUNDABERG**  
 2 Woongarra Street, Bundaberg, 4670  
 Phone: (07) 4152 0144 / Fax: (07) 4152 1335

**CAIRNS**  
 221 Scott Street, Bungalow, Cairns, 4870  
 Ph: (07) 4033 7933 / Fax: (07) 4033 7950

**GOLD COAST**  
 19 Central Drive, Burleigh Junction, 4220  
 Ph: (07) 5593 7933 / Fax: (07) 5593 7934

**HERVEY BAY**  
 93 Main Street, Hervey Bay, 4655  
 Ph: (07) 4124 1855 / Fax: (07) 4124 1851

**MACKAY**  
 95 Gordon Street, Mackay, 4740  
 Ph: (07) 4957 3886 / Fax: (07) 4957 2373

**MAROOCHYDORE**  
 100 Sugar Road, Maroochydore, 4558  
 Ph: (07) 5451 1155 / Fax: (07) 5479 4677

**MT ISA**  
 17 Simpson Street, Mt Isa, 4825  
 Ph: (07) 4749 0650 / Fax: (07) 4749 0901

**ROCKHAMPTON**  
 212 Denison Street, Rockhampton, 4700  
 Ph: (07) 4927 6844 / Fax: (07) 4922 4087

**TOOWOOMBA**  
 46 Water Street, Toowoomba, 4350  
 Ph: (07) 4639 1089 Fax: (07) 4632 1455

**TOWNSVILLE**  
 55 - 63 Dalrymple Road, Garbutt, 4814  
 Ph: (07) 4775 3033 / Fax: (07) 4775 3777

**NEW SOUTH WALES**  
**SYDNEY - BROOKVALE**  
 56 Chard Road, Brookvale, 2100  
 Ph: (02) 9905 5520 / Fax: (02) 9905 2664

**SYDNEY - CARLTON**  
 159 Bellevue Parade, Carlton, 2218  
 Ph: (02) 9547 3355 / Fax: (02) 9547 0495

**SYDNEY - HORNSBY**  
 18 James Street, Hornsby, 2077  
 Ph: (02) 9477 5738 / Fax: (02) 9482 7175

**SYDNEY - KINGS PARK**  
 1/12 Garling Road, Kings Park, 2148  
 Ph: (02) 9622 1000 / Fax: (02) 9831 4735

**SYDNEY - NARELLAN**  
 6/3 Yarmouth Place  
 Narellan Business Park, Narellan, 2567  
 Ph: (02) 4647 1277 / Fax: (02) 4647 4177

**SYDNEY - PENRITH**  
 Unit 2/116-120 Old Bathurst Road,  
 Emu Plains, 2750  
 Ph: (02) 4735 6691 / Fax: (02) 4735 6124

**ALBURY**  
 321 Townsend Street, Albury, 2640  
 Ph: (02) 6021 5544 / Fax: (02) 6021 8539

**ARMIDALE**  
 57 Newton Street, Armidale, 2350  
 Ph: (02) 6771 1781 / Fax: (02) 6771 5591

**DUBBO**  
 42 Buljie Street, Dubbo, 2830  
 Ph: (02) 6885 3777 / Fax: (02) 6882 0600

**LISMORE**  
 49 Habib Drive, South Lismore, 2480  
 Ph: (02) 6621 7000 / Fax: (02) 6622 0363

**MUSWELLBROOK**  
 11 Maitland Street, Muswellbrook, 2333  
 Ph: (02) 6543 3333 / Fax: (02) 6543 3541

**NEWCASTLE**  
 65 Northville Drive, Barnsley, 2278  
 Ph: (02) 4953 3288 / Fax: (02) 4953 1916

**ORANGE**  
 37 Peisley Street, Orange, 2800  
 Ph: (02) 6361 7999 / Fax: (02) 6361 2899

**TAMWORTH**  
 30 Bridge Street, Tamworth, 2340  
 Ph: (02) 6762 0541 / Fax: (02) 6762 0809

**TAREE**  
 44 Crescent Avenue, Taree, 2430  
 Ph: (02) 6551 2479 / Fax: (02) 6552 7544

**WAGGA WAGGA**  
 1 Dabney Avenue, Wagga Wagga, 2650  
 Ph: (02) 6925 4770 / Fax: (02) 6925 4969

**WOLLONGONG**  
 216 Carrimal Street, Wollongong, 2500  
 Ph: (02) 4227 4888 Fax: (02) 4227 4414

**VICTORIA**  
**MELBOURNE - COBURG**  
 683 Sydney Road, Coburg, 3058  
 Ph: (03) 9354 1116 / Fax: (03) 9354 1423

**MELBOURNE - DANDENONG**  
 166 Princess Hwy, Dandenong, 3175  
 Ph: (03) 9792 1116 / Fax: (03) 9792 9130

**MELBOURNE - SEAFORD**  
 37 Hartnett Drive, Seaford, 3198  
 Ph: (03) 9773 5573 / Fax: (03) 9773 5576

**BALLARAT**  
 422 Sutton Street, Ballarat, 3350  
 Ph: (03) 5335 9777 / Fax: (03) 5335 9400

**GEELONG**  
 27 Baldwin Avenue, North Geelong, 3215  
 Ph: (03) 5277 1444 / Fax: (03) 5277 1433

**SHEPPARTON**  
 190-192 Numurkah Road, Shepparton, 3630  
 Ph: (03) 5831 6388 / Fax: (03) 5831 6389

**SWAN HILL**  
 14 Chapman Street, Swan Hill, 3585  
 Ph: (03) 5032 9135 / Fax: (03) 5033 1596

**TRARALGON**  
 196 Argyle Street, Traralgon, 3844  
 Ph: (03) 5176 6666 / Fax: (03) 5174 0121

**TASMANIA**  
**HOBART**  
 120 Campbell Street, Hobart, 7000  
 Ph: (03) 6238 0380 / Fax: (03) 6238 0208

**DEVONPORT**  
 6 Steele Street, Devonport, 7310  
 Ph: (03) 6424 7155 / Fax: (03) 6424 9122

**LAUNCESTON**  
 68 Bolland Street, Launceston, 7250  
 Ph: (03) 6336 1515 / Fax: (03) 6336 1501

**ROCHERLEA**  
 274 George Town Road, Rocherlea, 7255  
 Ph: (03) 6336 0600 / Fax: (03) 6327 1179

**WIVENHOE**  
 61 Main Road, Wivenhoe, 7320  
 Ph: (03) 6431 9855 / Fax: (03) 6431 9848

**AUSTRALIAN CAPITAL TERRITORY**  
**CANBERRA**  
 87 Grimwade Street, Mitchell, 2911  
 Ph: (02) 6241 8161 / Fax: (02) 6241 7394

**CANBERRA**  
 30 Dundas Court, Phillip, 2606  
 Ph: (02) 6281 7410 / Fax: (02) 6281 7861

**SOUTH AUSTRALIA**  
**ADELAIDE**  
 163 Main North Road, Nailsworth, 5083  
 Ph: (08) 8344 6444 / Fax: (08) 8344 3222

**WESTERN AUSTRALIA**  
**PERTH**  
 Cnr South & Pritchard Streets, O'Connor, 6163  
 Ph: (08) 9331 2788 / Fax: (08) 9337 3037

**PERTH**  
 44-46 Frobisher Street, Osborne Park, 6017  
 Ph: (08) 9443 4848 / Fax: (08) 9443 8555

**NORTHERN TERRITORY**  
**DARWIN**  
 Unit 2, 498 Stuart Highway, Winnellie, 0820  
 Ph: (08) 8984 4926 / Fax: (08) 8947 0333

## INTERNATIONAL DISTRIBUTION NETWORK

**AMERICA - TJM Products**  
 (a business unit of CMI Operations)  
 2510 Quality Lane, Knoxville, Tennessee, 37931  
 Ph: (865) 670 1556 Fax: (865) 670 1993

**AMERICAN SAMOA - Asco Motors**  
 PO Box 129, Pago Pago,  
 Ph: 633 4281 / Fax: 633 4883

**AFRICA - EAST Romageco Kenya, Ltd.**  
 PO Box 43486, Nairobi, Kenya  
 Ph: (254) 02 553 151 / Fax: (254) 02 534 683

**AFRICA - SOUTH TJM South Africa**  
 385 Voortrekkers Road, Capital Park  
 Pretoria RSA,  
 Ph: (12) 329 4515 / Fax: (12) 329 4517

**AFRICA - West ESPS International**  
 5 Guma Drive (off Spur Rd),  
 Freetown, Sierra Leone.  
 Ph: (232) 3222 0037 / Fax: (232) 3222 0035

**EUROPE - TJM Products (Europe)**  
 Veerweg 6, 5171 PW Kaatsheuvel,  
 The Netherlands.  
 Ph: (31) 4165 40167 / Fax: (31) 4162 72304

**FIJI - Asco Motors**  
 Ratu Mara Road, Suva,  
 Ph: 38 4888 / Fax: 37 0309

**HAITI - RPM Imports Haiti**  
 6, Rue Ludovic Delmas 83, Port Au Prince, Haiti  
 Ph: (509) 558-4545 / Fax: (509) 510-7626

**HONG KONG & CHINA - 4WD Co.**  
 22 Man Lak Street, Hung Hum, Kowloon.  
 Ph: (852) 2392 6348 / Fax: 2309 7346

**ISRAEL - Henefeld Technologies Ltd.**  
 21 Alon Hatavor Street, Caesarea 38900 Israel.  
 Ph: 6627 2666 / Fax: 6627 1569

**JAPAN - Jaos Co. Ltd.**  
 3586-1, Hirobaba, Shinto, Gumma,  
 370-3504, Japan  
 Ph: +81-279-20-5511 / Fax: +81-279-20-5549

**KOREA - AM Co. Ltd**  
 Kumhak, B/D 2393  
 Sungnam - Dong, Jungwon - GU Sungnam City,  
 Kyounggi - Do, Korea.  
 Ph: (82) 317541 9898

**MALAYSIA - 4x4 Shoppe & Service**  
 2-M, Jalan Perdana 6/8  
 Pandan Perdana, 55300, Kuala Lumpur.  
 Ph: 03-9200 9844 / Fax: 03-9200 9744

**PHILIPPINES**  
 Armark International Corporation  
 172A Mabini Street, San Juan, 1503,  
 Metro Manila.  
 Ph: (02) 727 7201-03 / Fax: (02) 727 7207

**NEW ZEALAND**  
 Fully Equipped Head Office:  
 PO Box 75, Port Moresby,  
 Ph: (07) 850 7000 / Fax: (07) 850 7009  
 Auckland, Wellington, Canterbury  
 Ph: 0800 111 000

**PAPUA NEW GUINEA - ELA Motors**  
 PO Box 75, Port Moresby,  
 Ph: 322 9469 / Fax: 321 3507

**SRI LANKA - Outdoorsman**  
 71 A, Castle Street, Colombo -8,  
 Ph: (94) 071-22588 / Fax: (94) 1-320202

**THAILAND - LPIVA Intertrade Co., Ltd**  
 1108/5 Rama 4 Road  
 Sathorn, Bangkok 10120  
 Ph: (02) 249 0311-4 / Fax: (02) 249 9682

**TONGA - Asco Motors**  
 Taufa'ahau Road, Mailetaha.  
 Ph: 23 500 / Fax: 24 918

**TAIWAN - Guang Linn Trading Co. (G-Plus)**  
 824, Sec 4 Wen-Sin Road, Taichung, Taiwan R.O.C  
 Ph: (886) 4 22305738 / Fax: (886) 4 2232374

**UNITED ARAB EMIRATES**  
 Dubai 4WD Trade  
 PO Box 2689, Dubai, UAE  
 Ph: (971) 4282 5455 / Fax: (971) 4282 4544

**VANUATU - Asco Motors**  
 PO Box 18, Port Vila.  
 Ph: 22 341 / Fax: 23 374

**VENEZUELA - Auto Servicios Jumbo**  
 3-4 Transversal, Boletia Sur, Caracas  
 Ph/Fax: (212) 562-6431, 564-4879

**WESTERN SAMOA - Asco Motors**  
 PO Box 1856, Apia.  
 Ph: 20 800 / Fax: 22 601

**TJM WARRANTY POLICY:** TJM Products is committed to the supply of quality products and in support of this TJM offers a three year warranty on TJM manufactured products. TJM Canopies and also XGS 4wd Suspension. XGS Suspension is subject to a limit of fifty thousand kilometers. Any defects in a product distributed by TJM, but not manufactured by TJM, shall be dealt with in accordance with, and to the extent of, the warranty offered by the manufacturer of that product. All claims must be notified to TJM in writing with purchase receipt details and the faulty product returned to TJM for assessment where TJM shall repair or replace (at TJM's discretion) the defective product.

**EXPLANATORY NOTES:** TJM does not warrant that the products manufactured or marketed by it comply with the laws of the place where those goods are purchased or used. It is the sole responsibility of the purchaser to ascertain whether products being purchased, or the affixation of those products to any other object, comply with local laws. This warranty covers structural defect and workmanship but does not cover finishes, labour charges for removal or refitting, freight costs, accident damage, misuse or abuse, damage due to incorrect fitment or application, modified product, faulty design or consequential damage of any kind. All claims must be accompanied by the original sales receipt. This warranty covers only the cost of repairs or replacement of the product or part thereof. The decision of which remains

solely at the discretion of TJM Products Pty. Ltd. This warranty will not cover the cost of removal, installation or any transport. Enhanced finishes, such as polishing or powder coating are not subjected to this warranty. Further, damage or defects caused by collision, alteration, improper installation, road hazards, adverse conditions or usage for any other purpose other than normal private usage are not covered by this warranty. This warranty is in lieu of all other warranties expressed or implied.

**EXCLUSION FROM WARRANTY:** TJM does not warrant that the products manufactured or marketed by it comply with the laws of the place where those products are purchased or used. It is the sole responsibility of the Purchaser to ascertain whether products being purchased - or the affixation of those products to any other object - comply with local laws. Except to the extent described in the Warranty, TJM shall not be liable for any other claim including claims arising from incorrect fitment, product modification, faulty design, the use of the product and any indirect special or consequential damage or injury to any person, company or other entity. The warranty is excluded if any product manufactured or distributed by TJM is modified in appearance (including custom painting or finishing) or operation without express written consent of TJM.



**WARNING:** Some vehicles are equipped with air bags. The installation of a TJM frontal protection bar, side bars or winch-bar combination, could alter the vehicle's crush rate and operational characteristics of the air bag. Independent research has established that certain TJM bars when correctly installed do not affect the proper operation of the air bag triggering system in the vehicle. Only those TJM bars complied as air bag compatible are recommended by TJM for installation to air bag equipped vehicles. Even though there may be considerable benefits in installing TJM Bars they should not in themselves be considered as protection for either the vehicle or occupants in the event of a collision or accident.

**COPYRIGHT:** This Brochure is subject to Copyright. Copyright© Reserved 2004 TJM Products Pty Ltd. Additionally, certain products, and their associated trade marks, shown in this Brochure have been protected under trade mark, design and patent legislation. Legal proceedings may be commenced in respect of any infringements of such trade mark, patent or design right.

**RIGHTS RESERVED:** This Brochure is a guide only and TJM Products Pty Ltd take no responsibility for any errors or omissions of whatever nature. Due to continual improvement and design, the information, products, specifications and range contained in this Brochure is subject to change without notification at the sole discretion of TJM Products Pty Ltd.

Authorised TJM Outlet: